

SUPERIA

stilo<sub>grad</sub>

atlanta

**grid**sky

offset

imperial<sub>2.0</sub>

imperial<sub>2.5</sub>

imperial<sub>3.5</sub>

1	TIPOLOGIAS	PÁG. TI-01 e TI-02
2	GRÁFICOS DE DESEMPENHO	PÁG. GR-01 e GR-02
3	PERFIS	PÁG. PE-01 a PE-04
4	COMPONENTES	PÁG. CO-01 a CO-03

# 1 TIPOLOGIAS

## PELE DE VIDRO

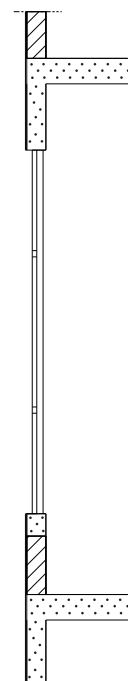
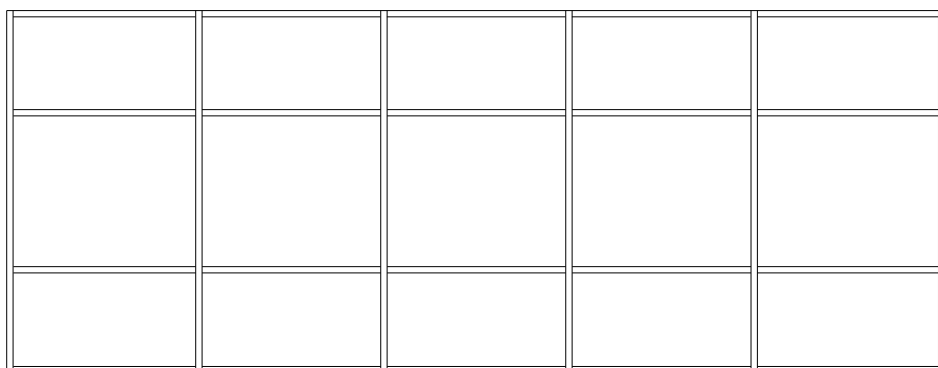

# 2

## GRÁFICOS DE DESEMPENHO

**4047**

3,137 kg/m

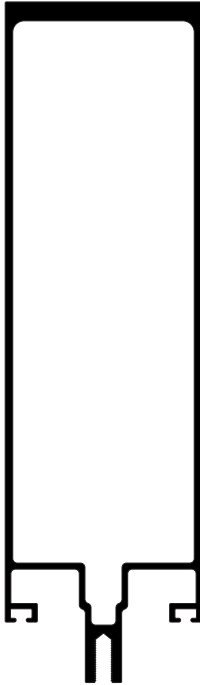

ESCALA 1:2

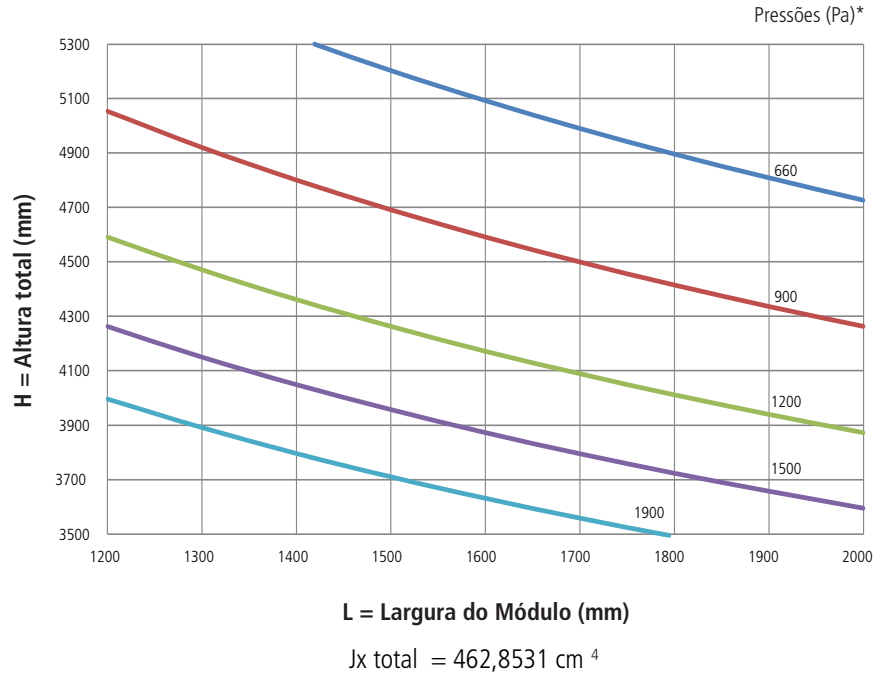

Liga 6060-T5

**4046**

2,145 kg/m

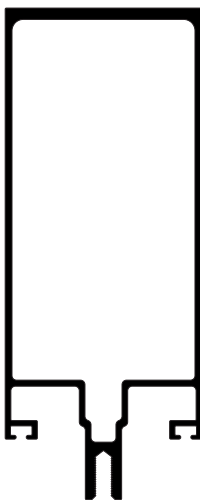

ESCALA 1:2

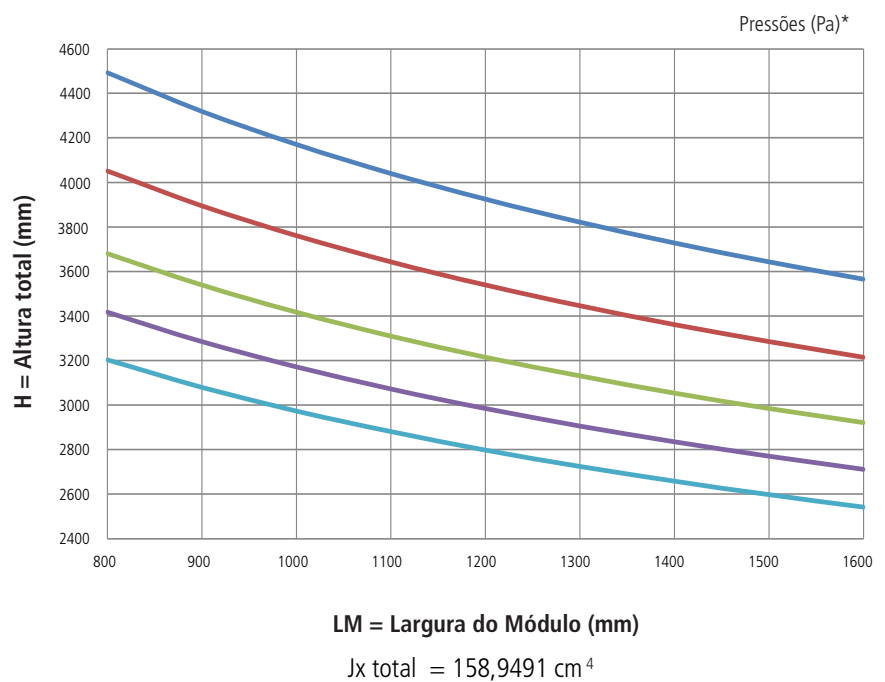

Liga 6060-T5

As informações contidas neste catálogo são de propriedade da BELMETAL e estão sujeitas a alterações sem aviso prévio. Verifique o site [www.belmetal.com.br](http://www.belmetal.com.br) para obter a versão mais atualizada.

# 3 PERFIS

4047

3,137 kg/m

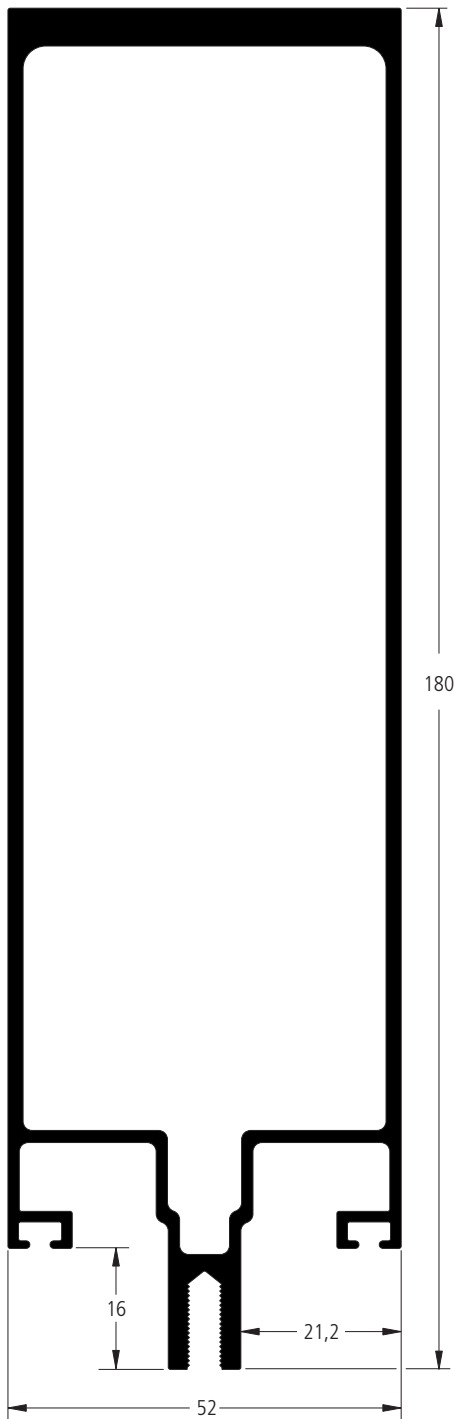

4046

2,145 kg/m

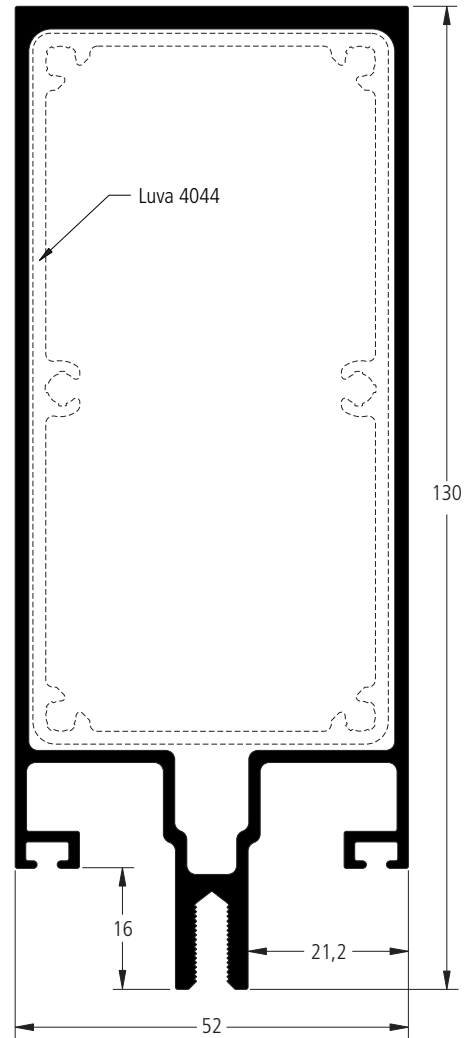

4050

0,306 kg/m

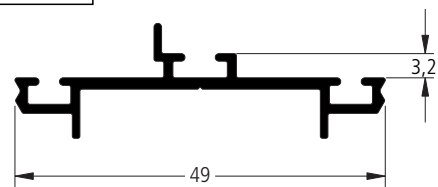

4052

0,246 kg/m

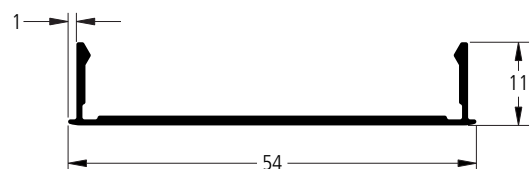



4044

1,451 kg/m

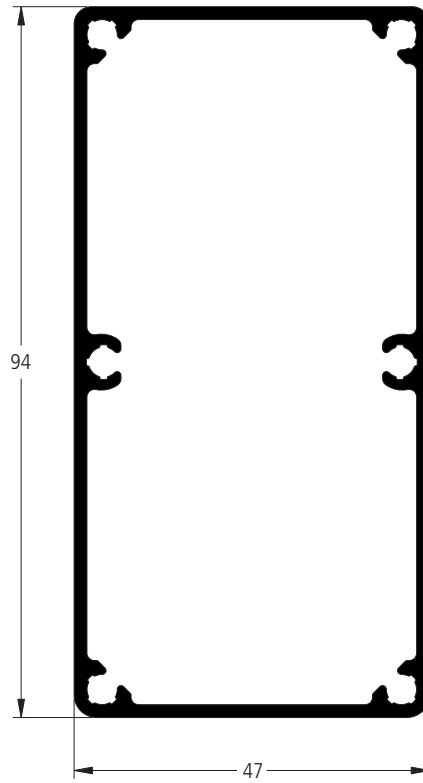

4051

0,225 kg/m

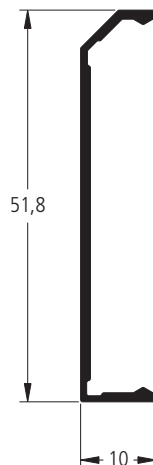

**4040**

0,743 kg/m

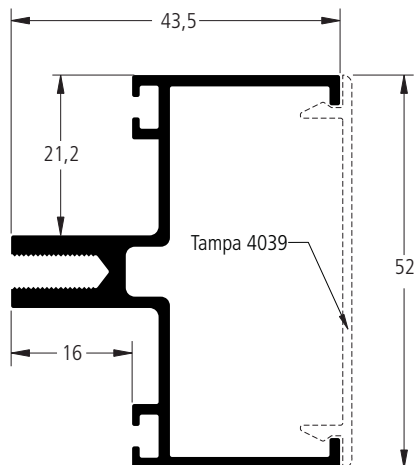

**4039**

0,212 kg/m

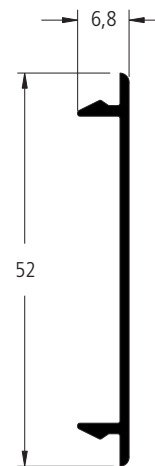

**4048**

1,505 kg/m

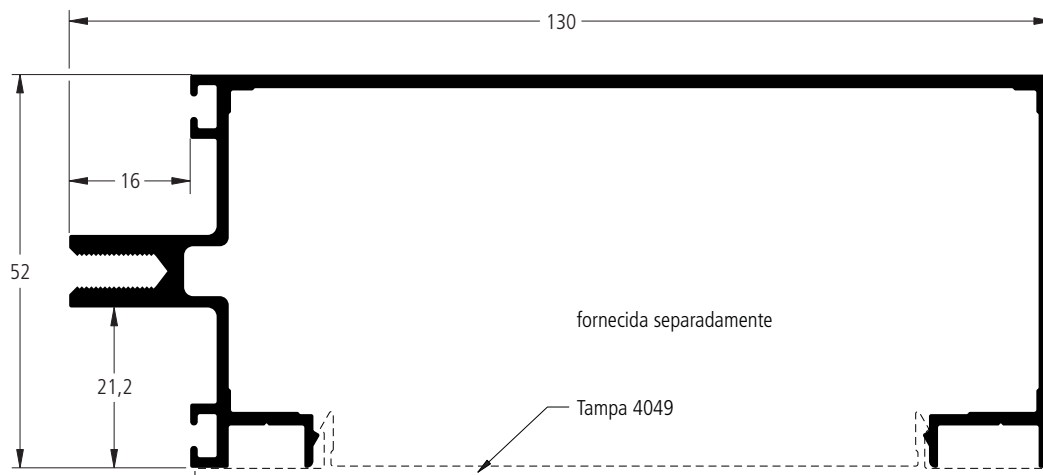

**4049**

0,477 kg/m

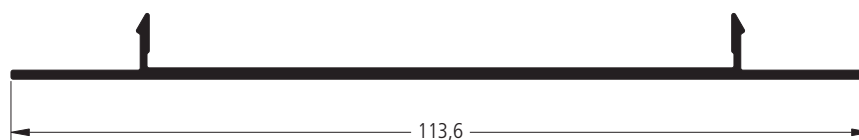

# 4 COMPONENTES

**BMT-GUA-2101-PRT**

Vidro 10 mm

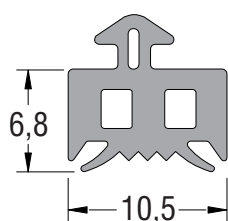

escala 2:1

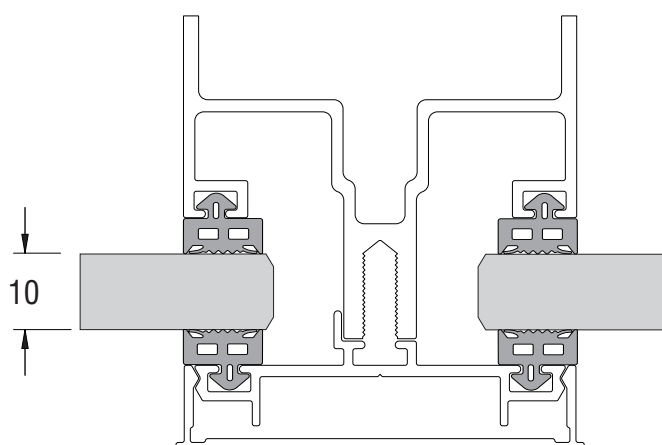

escala 1:1

**BMT-GUA-2102-PRT**

Vidro 8 mm

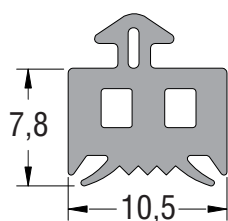

escala 2:1

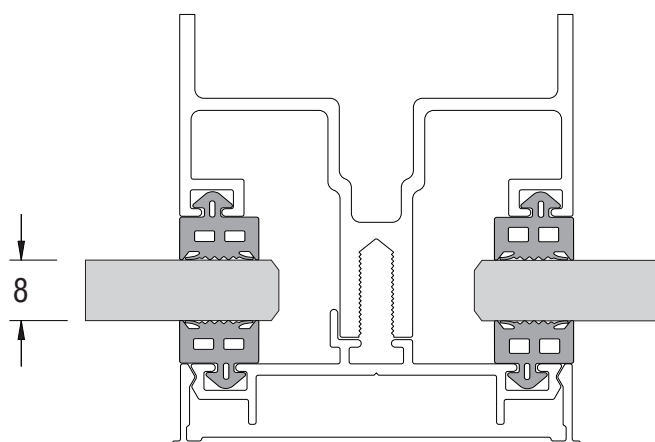

escala 1:1

**BMT-GUA-2103-PRT**

Vidro 6 mm

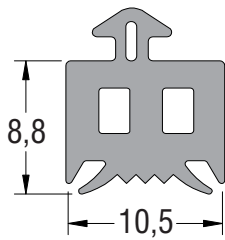

escala 2:1

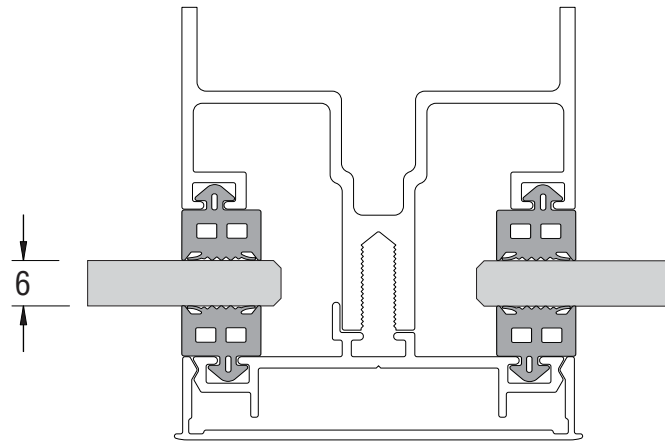

escala 1:1

**PRX-PRM-5016-NAT**

Parafuso INOX

